

Parts Manual Manuel de pièces



Gladiator 464

Sweeper
Code: 19677

Serial Number:
Numéro de série : _____

Date of Purchase:
Date d'achat : _____

Crankcase

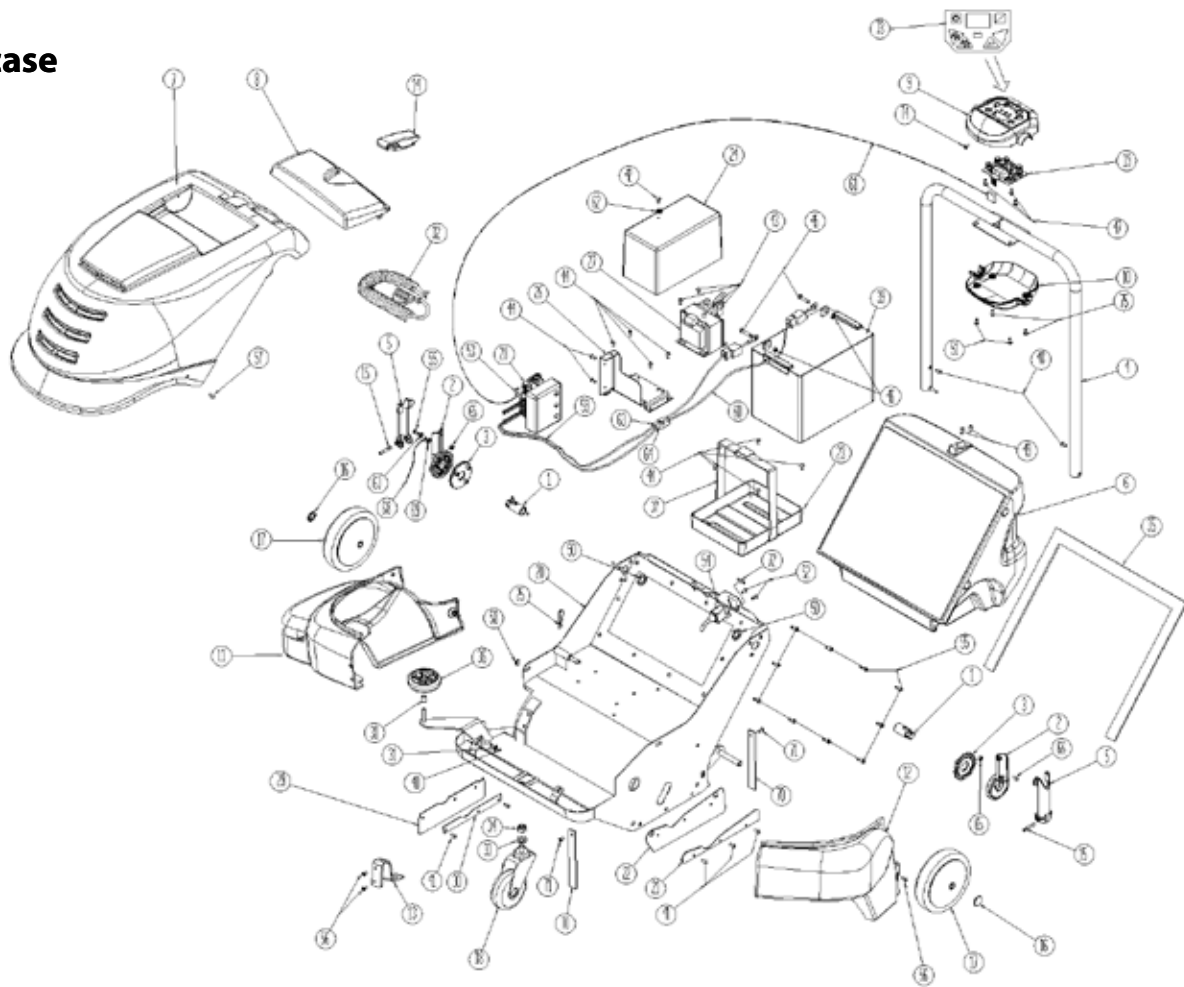

Ref.	Part N.	Description	Quantity	Validity From	Validity To
1	3LAFN01223	PIN ROTATING HANDLE	2		
2	3MPVR00914	HOOK	2		
3	3MPVR00915	HOOK	2		
4	3LAFN06583	HANDLE	1		
5	3MPVR00917	CLAMP HANDLE	2		
6	3MPVR05160	DRAWER WASTE	1		
7	3MPVR06000	HOOD COMPLETE	1	01/2012	
8	3MPVR04873	COVER	1		
9	3MPVR00926	INSTR. PANEL TOP	1		
10	3MPVR00927	INSTR. PANEL LOWER	1		
11	3MPVR05157	COVER RIGHT	1		
12	3MPVR05158	COVER LEFT	1		
13	3LAFN06806	BRACKET FIXED SIDE	1		
14	3MPVR00902	HANDLE DRAWER LOCK	1		
15	3LAFN01237	PIN LOCKING HANDLE	2		
16	3VTVR00305	WASHER RETAINING DIAMETER	2		
17	3RTRT00039	WHEEL BACK	2		
18	3RTRT00040	WHEEL FRONT	1		
19	3MECE00020	BOARD DISPLAY	1		

Crankcase

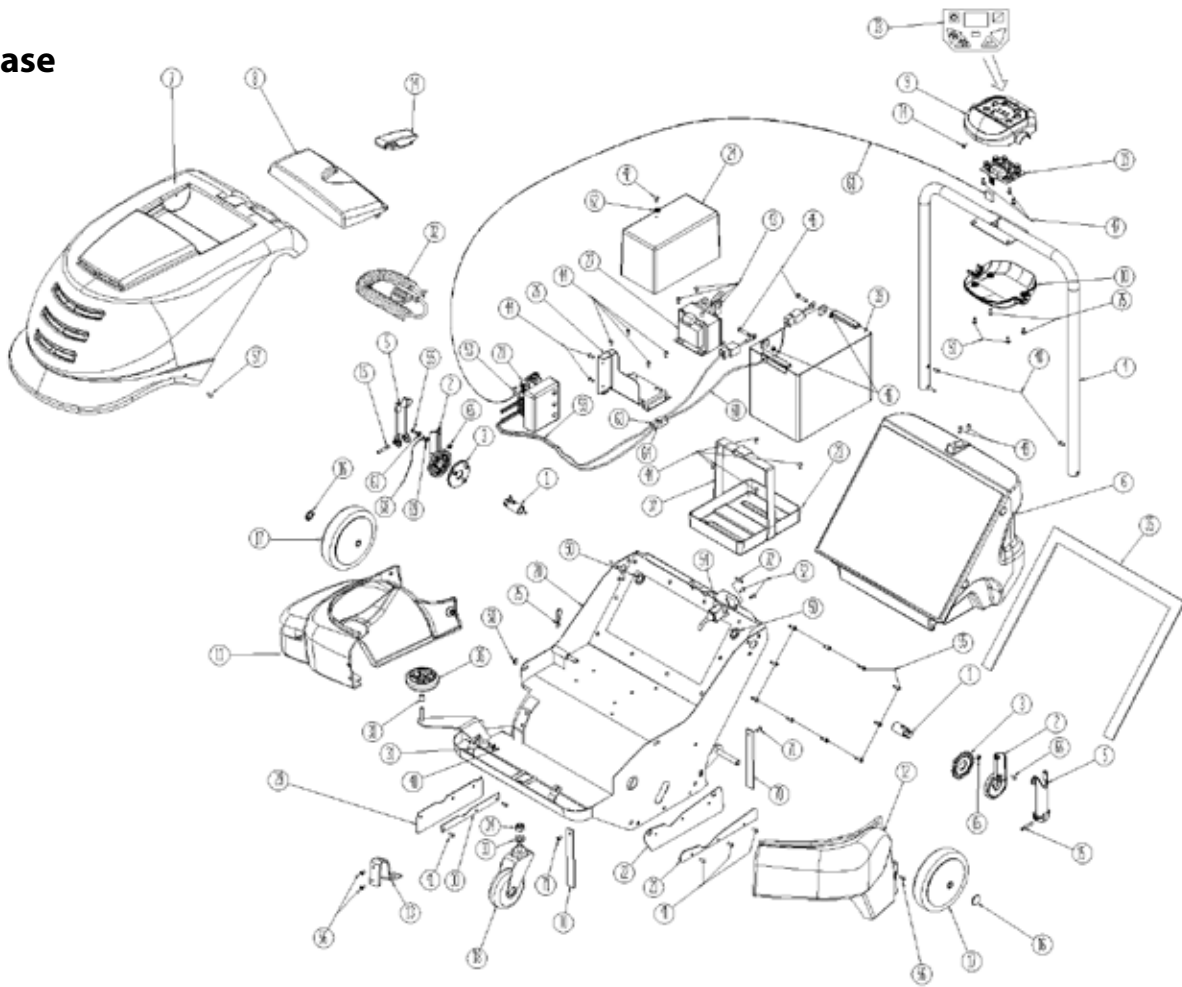

Ref.	Part N.	Description	Quantity	Validity From	Validity To
20	3LAFN01219	FRAME P203	1		
21	3LAFN01235	PLATE FIXED FLAP SX	1		
22	3MPVR00938	FLAP SIDE SX	1		
23	3MPVR05106	CONTAINER BATTERY	1		
24	3MPVR05105	COVER POWER BOARD	1		
25	3VTVR47052	SPLIT PIN "R" D.2x43 ZC	1		
26	3LAFN01236	SUPPORT POWER BOARD	1		
27	3MECE00408	TRANSFORMER FOR BATTERY CHARGER	1		
28	3MECE00025	PCB 460	1		
29	3MPVR00937	FLAP SIDE DX	1		
30	3LAFN01234	PLATE FIXED FLAP DX	1		
31	3VTRS00011	WASHER UNI 6592 6x12 ZB	1		
32	3MECB00923	EXTENSION AWG18 US PLUG	1		
33	3VTRS86510	WASHER 15x24 UNI6592	1		
34	3VTDD00012	NUT 985 M12 ZB	1		
35	3MPVR01708	KIT KIT MOUSSE SILVER 460	1		
36	3RTRT00011	WHEEL D.150 GRI/NR PARAC.SILVER	1		
37	3MTCG00011	BELT FLEXIBLE FOR BATTERY	1		
38	3LAFN75911	SPACER D.12 h.7	1		

Crankcase

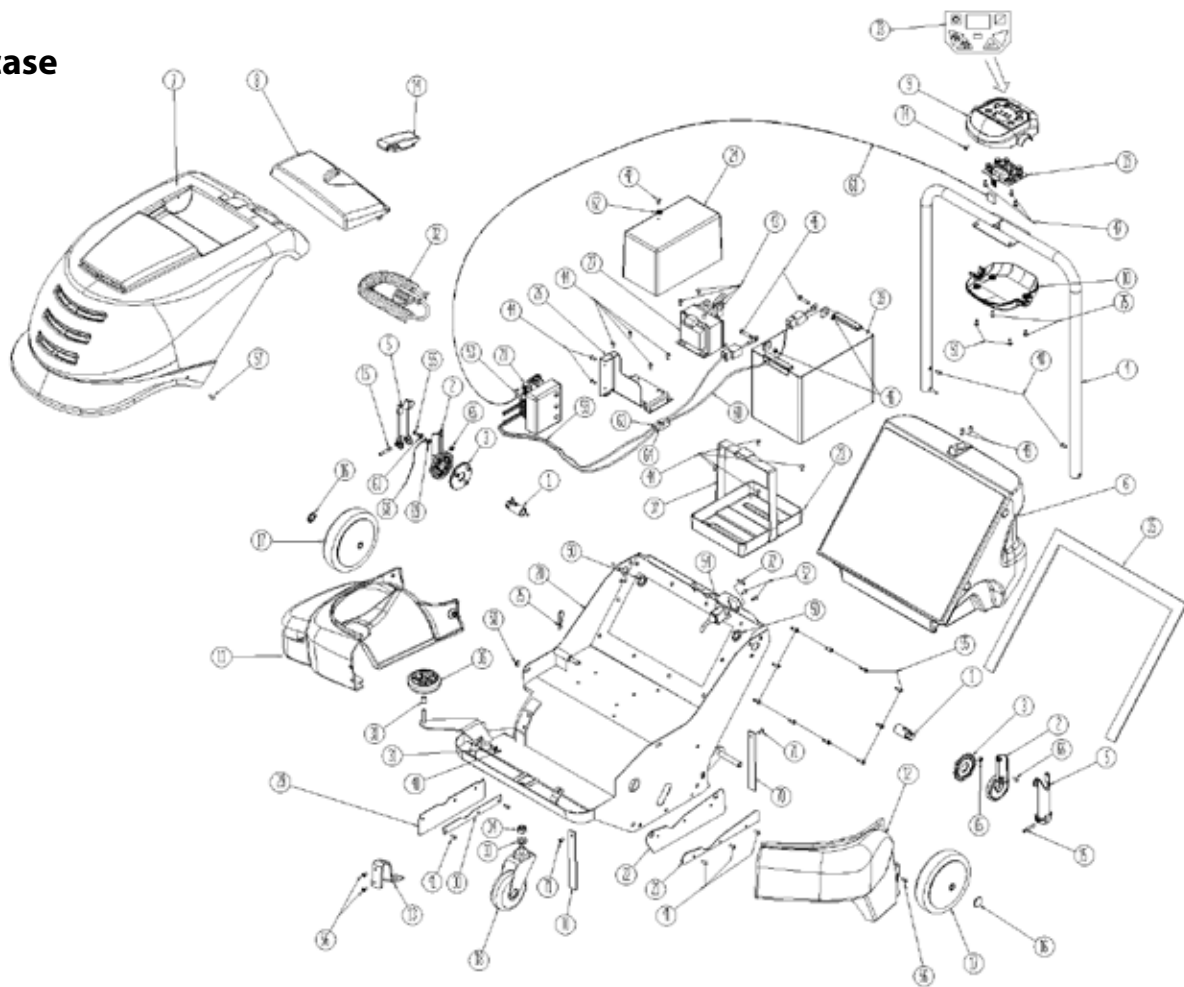

Ref.	Part N.	Description	Quantity	Validity From	Validity To
39	3BAAC00019	BATTERY 12V 42AH/20H AGM	1		
40	3VTAE48552	CIRCLIP D.6 UNI 7435	1		
41	3VTVT00800	SCREW TC 4x12 ZN	5		
42	3VTVT00003	SCREW TE M 4x12 ZC. UNI 5739	1		
43	3VTVT72043	SCREW M 4x16 TC UNI7687	4		
44	3VTVT0003	SCREW TE M 4x12 ZC. UNI 5739	10		
45	3VTVT00104	SCREW TE UNI 5739 6x18 ZB	2		
46	3VTDD00482	NUT M 6 ZIN UNI 5588	2		
47	3VTDD00002	NUT UNI 5588 M4 ZB	3		
48	3VTVT00993	SCREW TC UNI 8112	2		
49	3VTVT00075	SCREW TSCE UNI 5933 5x20 ZB	2		
50	3LAFN06270	RING NUT BLOCKING	2		
51	3VTVT14062	SCREW TE 5x16 UNI5739	4		
52	3VTVT01353	SCREW TSCE UNI 5933 3x8 ZB	2		
53	3MEVR00039	FUSE REED	1		
54	3MEVR01930	PLUG FUSED	1		
55	3VTVT83145	SCREW TSCE UNI 5933 5x15 ZB	11		
56	3VTVT75726	SCREW TBEI M 6x16 ISO 7380 ZB	4		
57	3VTVT09916	SCREW TBEI M 6x20 ISO 7380 ZB	2		

Crankcase

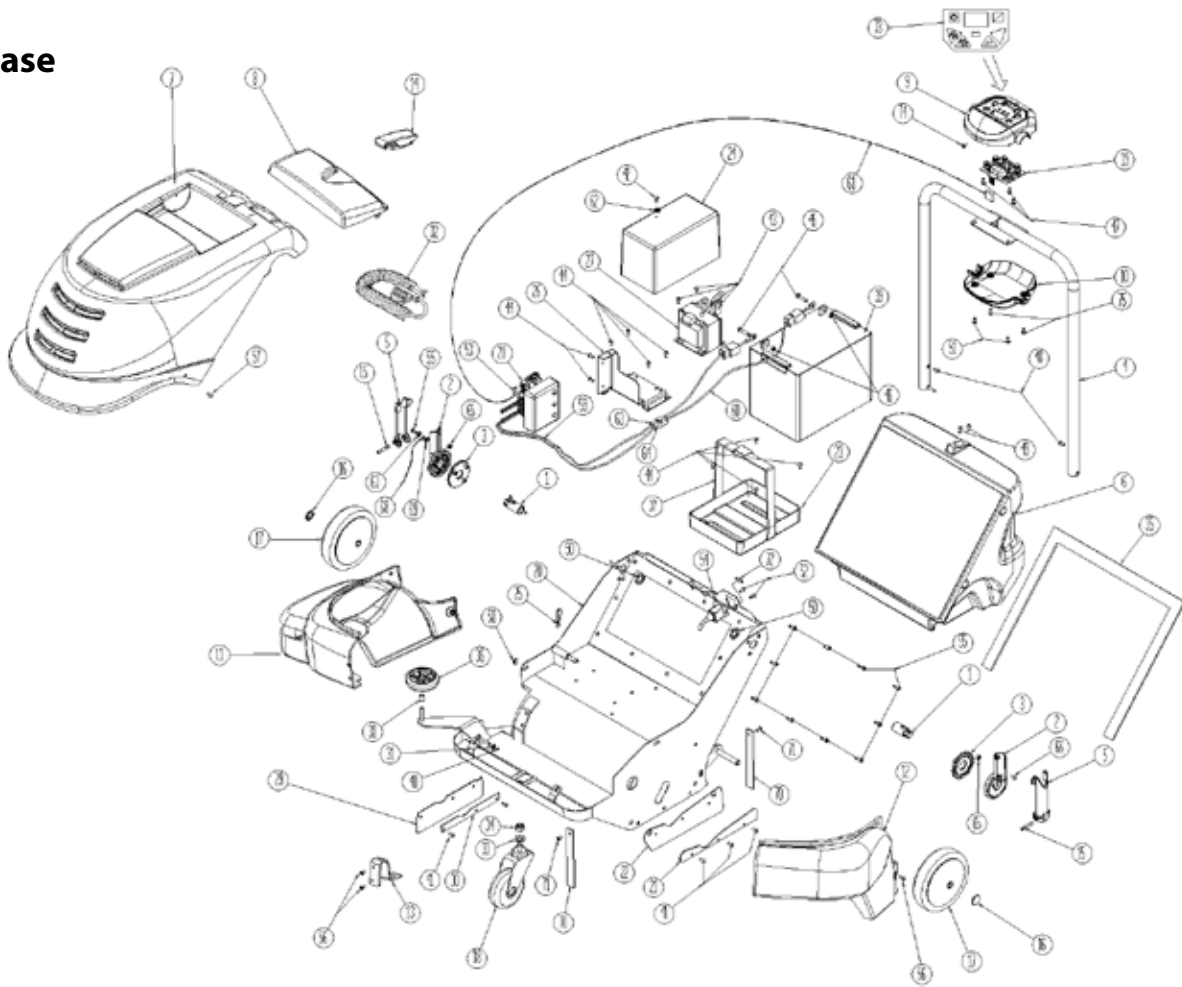

Ref.	Part N.	Description	Quantity	Validity From	Validity To
58	3VTDD00501	NUT CAGED	4		
59	3MECE00026	WIRING SILVER 460 E	1		
60	3MECB00924	CABLE COLL.BATT. +CAPPUC	1		
61	3MECE00023	CABLE PCB DISPLAY	1		
62	3VTRS15959	WASHER D. 4x12 UNI 6593	1		
63	3MEVR00082	CONNECTOR BLACK BODY	1		
64	3MEVR00083	CONNECTOR RED BODY	1		
65	3VTDD00017	NUT AUTOBLOK DIN 985 M5	2		
66	3VTVT05726	SCREW M 5x12 TSPI ZC. UNI5933	1		
67	3VTRS00010	WASHER UNI 6592 5x10 ZB	1		
68	3MECB00971	WIRING	1		
69	3VTRS03924	WASHER D.5 DIN 6798E	1		
70	3MPVR04693	RUBBER	2		
71	3VTVT62920	SCREW TE F/ROUND. M 6x16 ZB	2		
72	3MEVR01986	FUSE 2.5 A 250V 5X20	1		
73	3ETET00146	LABEL DASHBOARD P203	1		

Brush

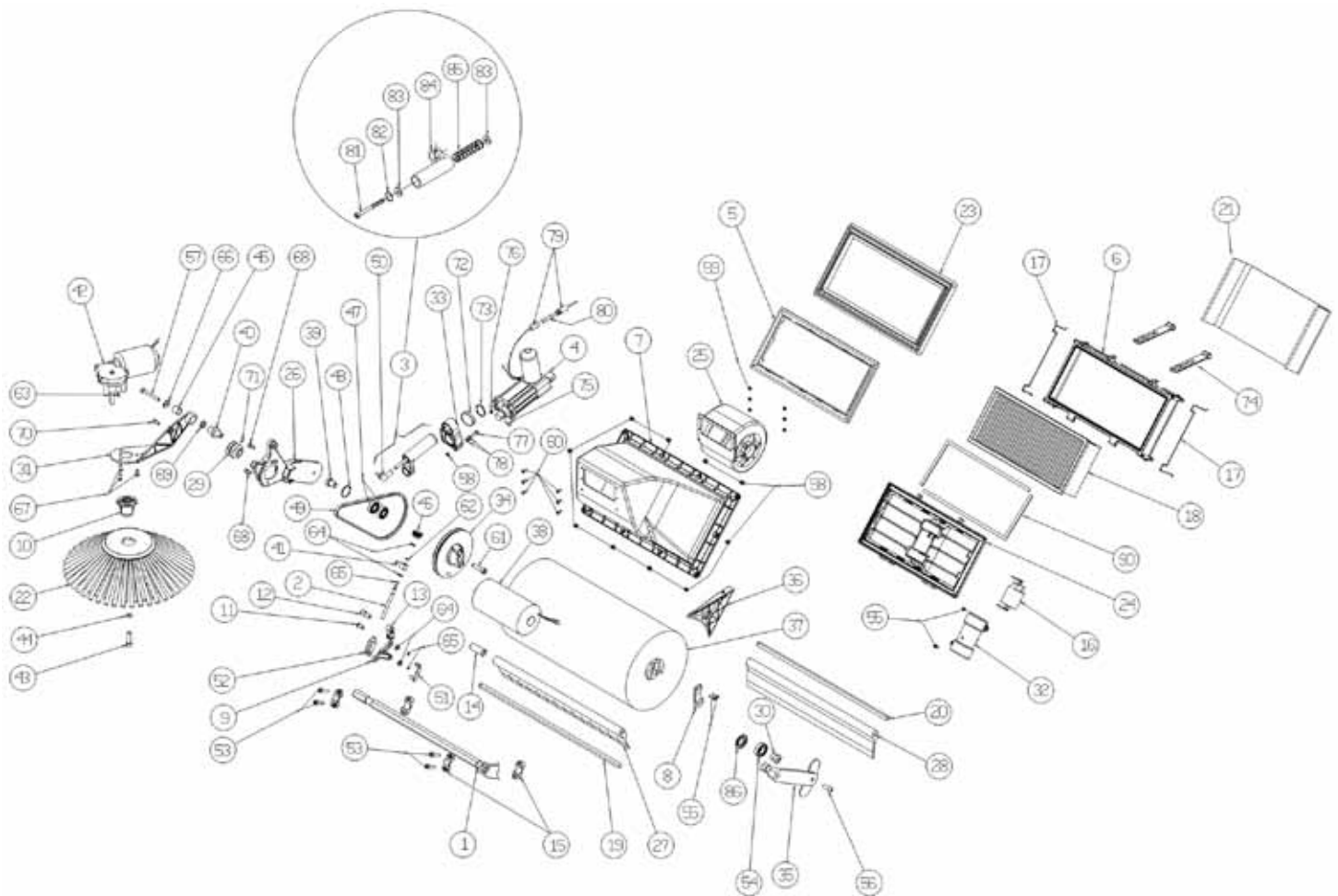

Ref.	Part N.	Description	Quantity	Validity From	Validity To
1	3ALTR00041	SHAFT BRUSH CENTRAL COMMAND	1		
2	3ALTR00042	ROD CONTROL SWITCH	1		
3	3PMVR00438	CASE COMPLETE	1		
4	3MOCC00034	ACTUATOR CENTRAL BRUSH	1		
5	3MPVR00918	CLAMP CHASSIS FILTER SHAKER	1		
6	3MPVR00919	CLAMP FILTER	1		
7	3MPVR00920	CRANKCASE FAN	1		
8	3PMVR00333	LEVER HOOKING BRUSH	1		
9	3MPVR00934	ARM REFERENCE BRUSH LAT .	1		
10	3MPVR01707	HUB SIDE BRUSH	1		
11	3MPVR00932	PIN ROD	1		
12	3LAFN01227	PIN CONTROL ARM BRUSH LAT.	1		
13	3MPVR00916	CONNECTING ROD REFERENCE BRUSH	1		
14	3LAFN01221	SPACER FLAP FRONT	1		
15	3MPVR00807	SUPPORT ARM REG. BRUSH	2		
16	3MOCC00035	MOTOR FILTER SHAKER	1		
17	3MLML00040	SPRING PREFILTER	2		
18	3FTDP00013	FILTER PAPER	1		

Brush

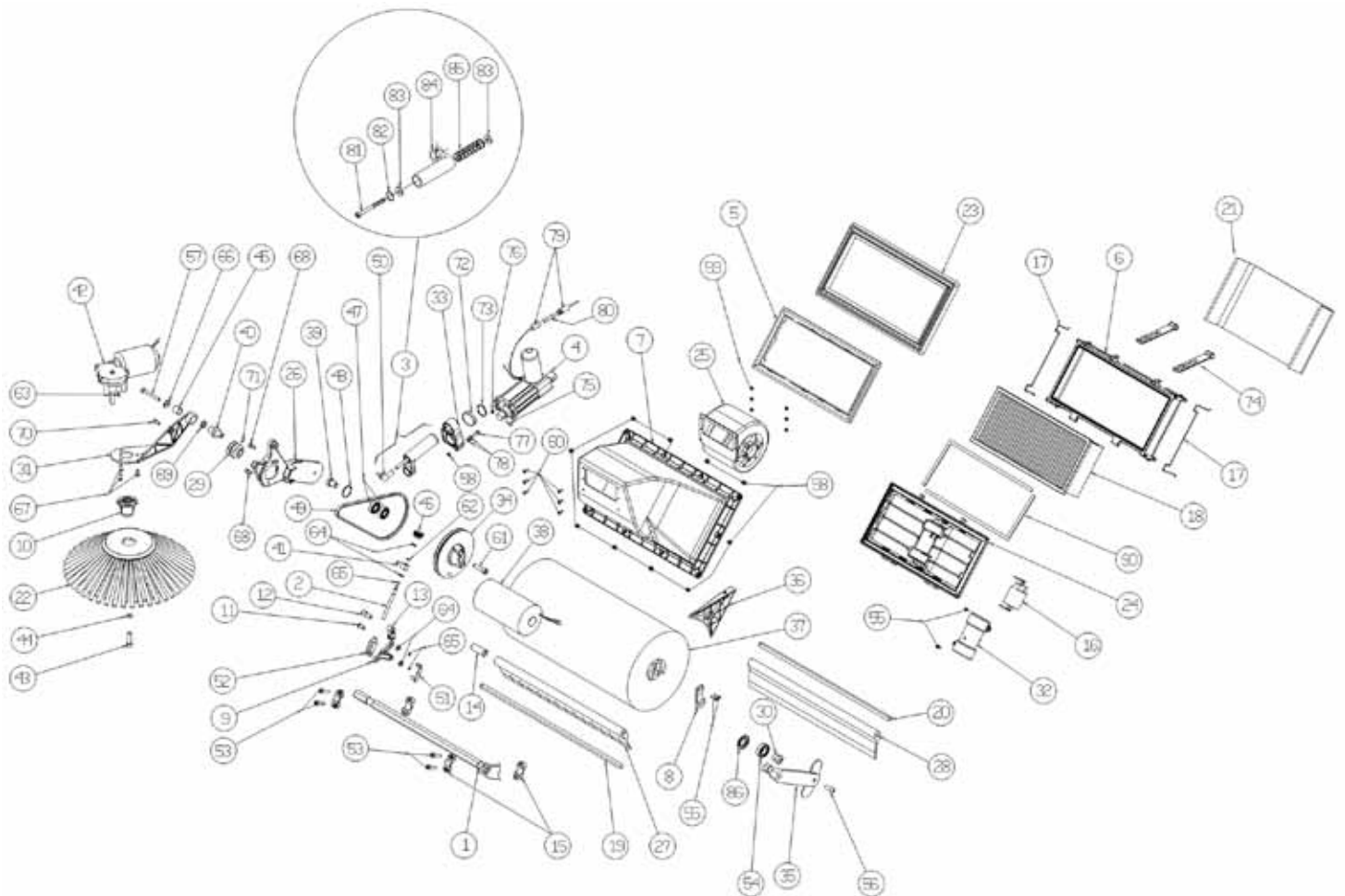

Ref.	Part N.	Description	Quantity	Validity From	Validity To
19	3LAFN01232	PIN DOOR FLAP FRONT	1		
20	3LAFN01233	PIN DOOR FLAP BACK	1		
21	3FTDP00014	FILTER P203	1		
22	3SPPV00303	BRUSH SIDE	1		
23	3MPVR00931	GASKET HOLDER	1		
24	3MPVR00933	FRAME SHAKER	1		
25	3MOCC00036	MOTOR	1		
26	3MFVR00025	ARM BRUSH CENTR. LAT. TRACT.	1		
27	3MPVR00935	FLAP FRONT	1		
28	3MPVR00936	FLAP BACK	1		
29	3MTPL00038	PULLEY ENGINE CENTRAL BRUSH	1		
30	3LAFN01230	PIN CENTRAL BRUSH LAT. SX	1		
31	3LAFN15263	ARM BRUSH SIDE	1		
32	3MPVR00925	COVER SHAKER	1		
33	3MPVR00943	GUIDE SPRING	1		
34	3MTPL00039	PULLEY	1		
35	3MFVR00026	ARM	1		
36	3MPVR00940	CONVEYOR P203	1		

Brush

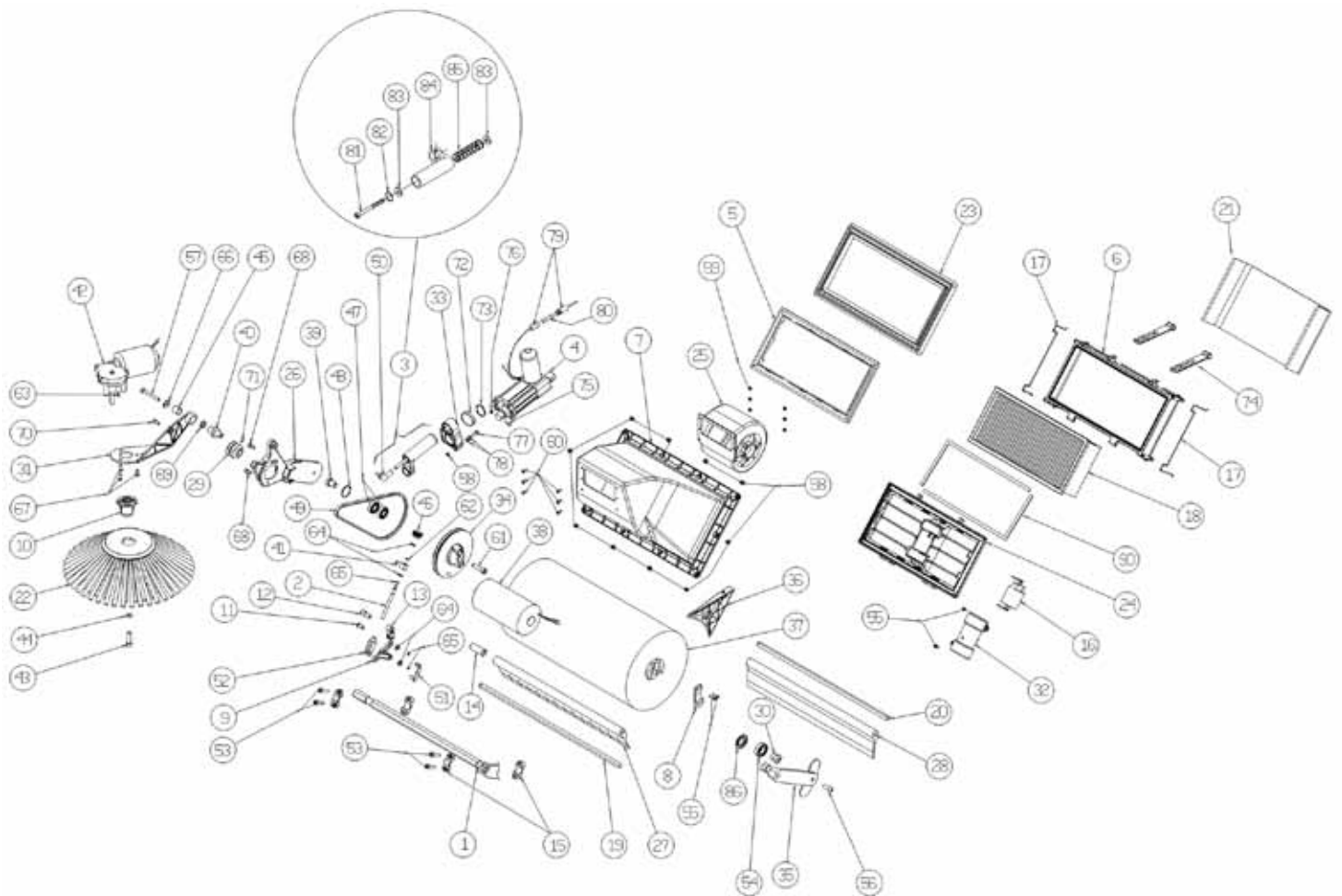

Ref.	Part N.	Description	Quantity	Validity From	Validity To
37	3PMVR01121	BRUSH BRUSH CENTRAL COMMAND	1		
38	3MOCC00033	MOTOR CENTRAL BRUSH	1		
42	3MTIG00002	GEAR MOTORIDUT D.63 BRACC EL			
43	3VTVT29884	SCREW TE M 4X 16 UNI 5739	1		
44	3VTRS05904	WASHER D. 4 X16 2.083	1		
45	3LAFN06774	BUSHING GLYCODUR GLY.PG 14-16-15F	1		
46	3VTVR00303	HANDWHEEL V1/30/BFC-M5	1		
47	3CUVR46942	BALL BEARING 6001-2RS1 -SKF	2		
48	3VTAE00010	CIRCLIP INTERNAL DIN 472 D.28	1		
49	3MTCG00019	BELT POLY 610 J 3	1		
50	3VTVR45280	ARTICULATION AS M6	1		
51	3CMCV00009	CLIP UNI 1676	1		
52	3CMCV00006	FORK UNI 1676 M6X24	1		
53	3VTVT06237	SCREW TCEI 6X20 UNI5931	4		
54	3CUVR00164	BEARING 6002RS -SKF-	1		
55	3VTVT00099	SCREW AUTOF.TC UNI 6954 3,9X13	2		

Brush

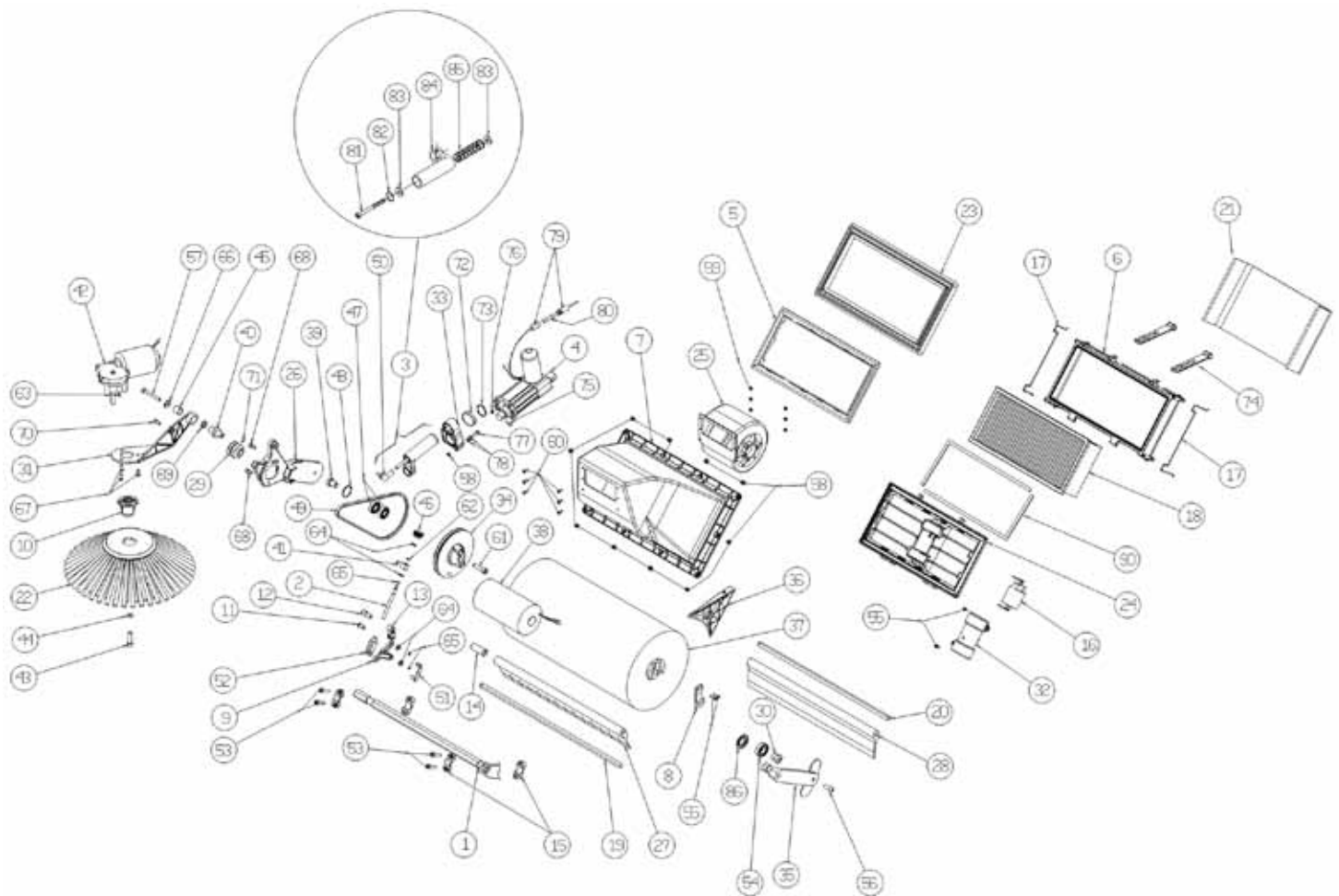

Ref.	Part N.	Description	Quantity	Validity From	Validity To
56	3VTVT87271	SCREW TBEI M 8X 16 ISO 7380	1		
57	3VTVT00063	SCREW TCCE UNI 5931 6X50 ZB	1		
58	3VTDD00017	NUT 985 M5	12		
59	3VTDD00009	NUT 985 M4 BASS	6		
60	3VTVT00003	SCREW TE M 4X 12 ZC. UNI 5739	6		
61	3VTVT01354	SCREW TCCE UNI 5931 8X35 ZB	1		
62	3GUGO00288	GASKET	1		
63	3VTVR75730	KEY UNI 6606 3 X 3,7	1		
64	3VTRS00011	WASHER UNI 6592 6X12 ZB	4		
65	3VTAE48552	CIRCLIP D. 6 UNI 7435	3		
66	3VTRS63242	WASHER D. 6 X24 ZC	1		
67	3VTVT62920	SCREW TE F/ROND. M 6X 16 ZB	3		
68	3VTVT00005	SCREW TE FR 5X12 ZB	1		
69	3 VTRS00029	THICKNESS 15X22X0,2	2		
70	3VTVT00005	SCREW TE FR 5X12 ZB	1		
71	3VTVT00989	GRUB SCREW 4X8 KNURLED CUP	1		

Brush

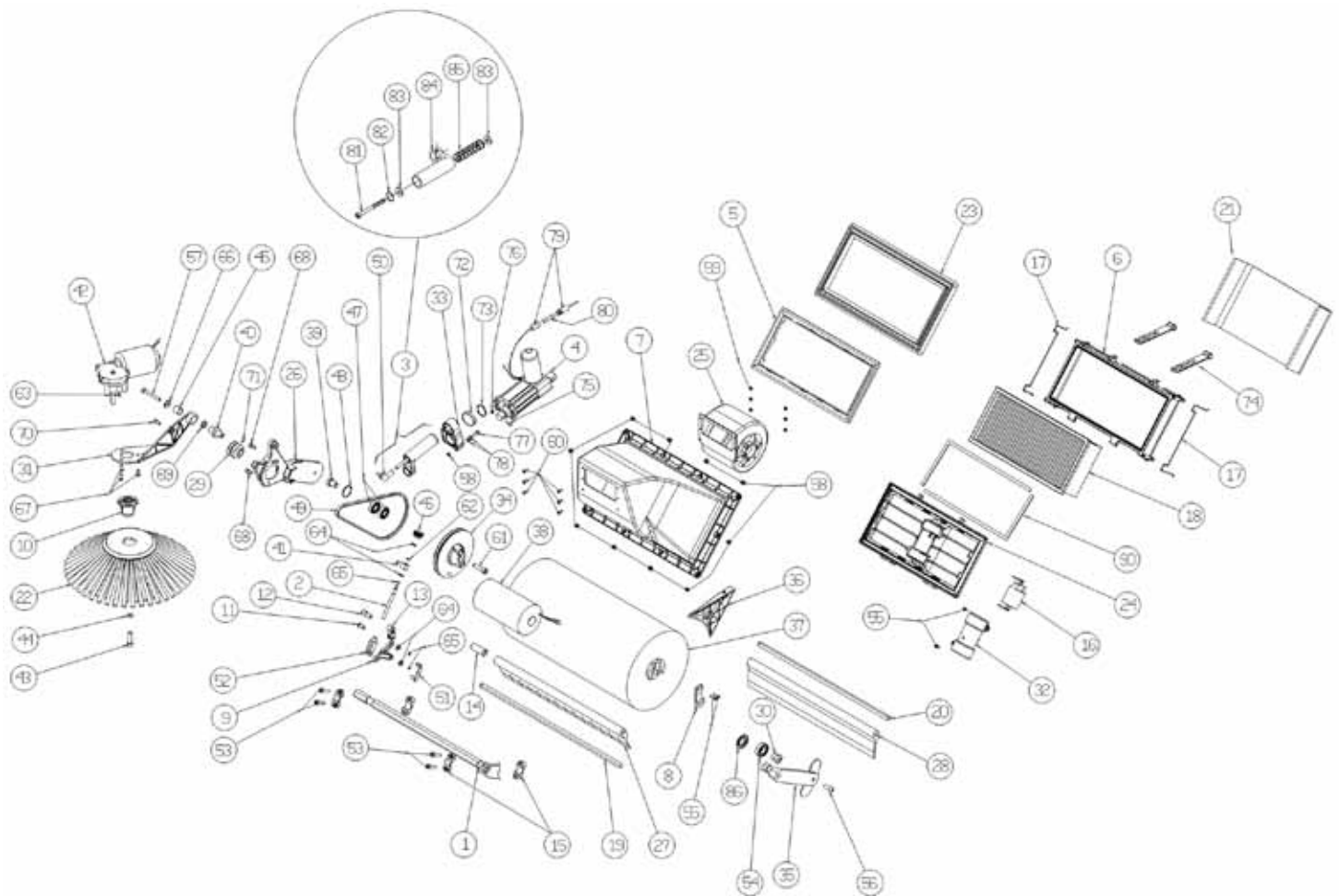

Ref.	Part N.	Description	Quantity	Validity From	Validity To
72	3LAFN06775	SPACER	1		
73	3VTAE09655	CIRCLIP D. 25 UNI 7435	1		
74	3MPVR04648	TIE ROD FIXED FILTER	2		
75	3VTVT00245	SCREW TE M6X30 UNI 5739	1		
76	3VTDD00010	NUT 985 M6 BASS	1		
77	3VTVT00847	SCREW TBEI M5X25 INOX	2		
78	3VTRS00010	WASHER UNI 6592 5X10 ZB	2		
79	3MECB00925	CABLE CONNECTION ACTUATOR	1		
80	3MEVR00150	FUSE 2.5 A 250V 5X20	1		
81	3VTVT37013	SCREW TE M 6X100 UNI 5737	1		
82	3VTAE00009	SEEGER INTERNAL DIN 472 D.20	1		
83	3LAFN00124	BUSHING BATTING CYLINDER	2		
84	3LAFN01238	GUIDE SPRING CASE	1		
85	3MLML45281	SPRING TK1400	1		
86	3LAFN07372	CAP PROTECTION BEARING	1		
90	GUGO00414	GASKET FRAME SHAKER	2		

Electric Diagram

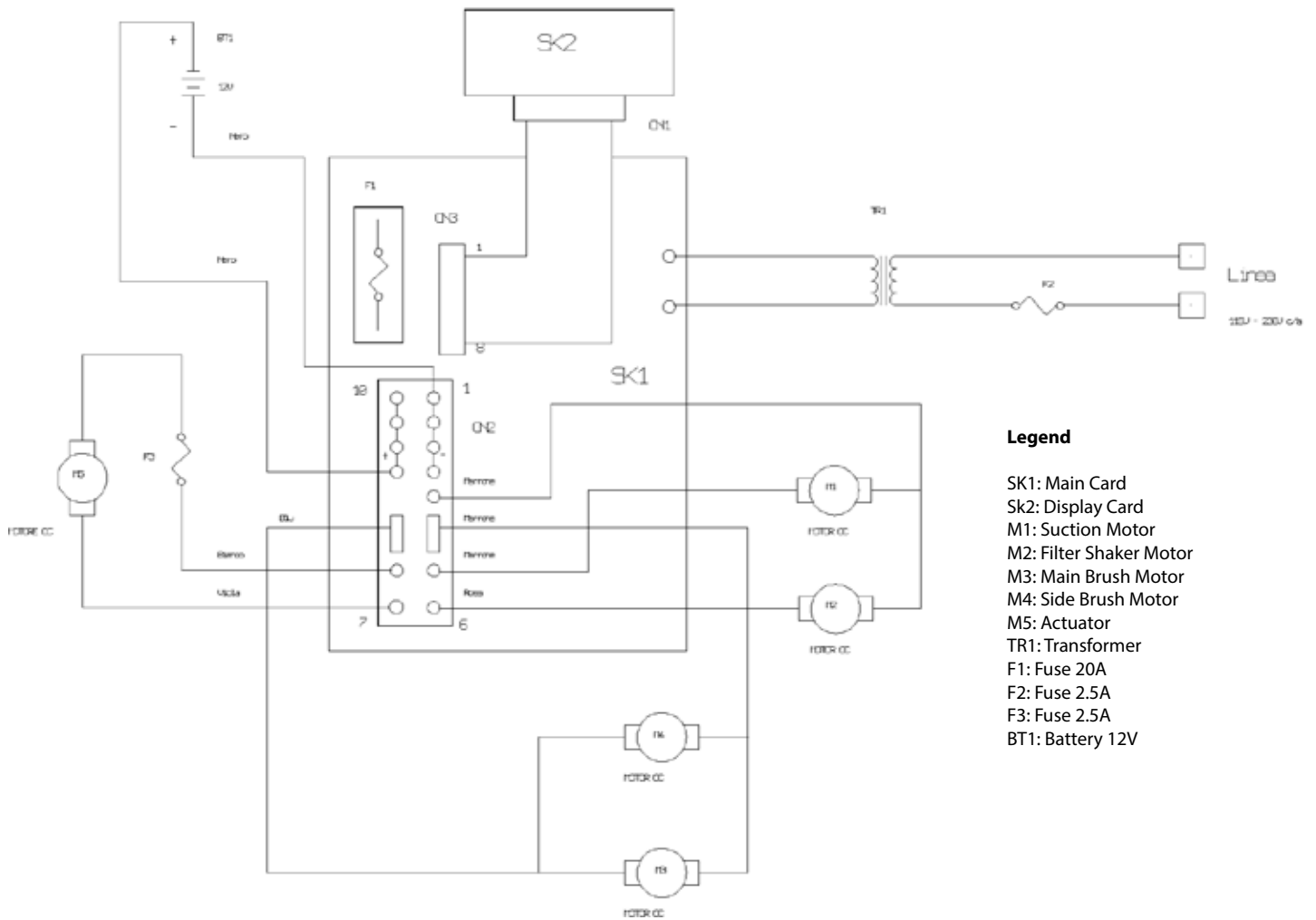

Legend

- SK1: Main Card
- SK2: Display Card
- M1: Suction Motor
- M2: Filter Shaker Motor
- M3: Main Brush Motor
- M4: Side Brush Motor
- M5: Actuator
- TR1: Transformer
- F1: Fuse 20A
- F2: Fuse 2.5A
- F3: Fuse 2.5A
- BT1: Battery 12V

Ref.	Part N.	Description	Quantity	Validity From	Validity To
BT1	3BAAC00019	BATTERY 42AH/20H AGM	1		
F1	3MEVR00039	FUSE REED 20A	1		
F2	3MEVR00150	FUSE 2.5 A 250V 5X20	1		
F3	3MEVR00150	FUSE 2.5 A 250V 5X20	1		
M1	3MOCC00036	MOTOR SUCTION	1		
M2	3MOCC00035	MOTOR FILTER SHAKER	1		
M3	3MOCC00033	MOTOR CENTRAL BRUSH	1		
M4	3MOCC00037	MOTOR SIDE BRUSH	1		
M5	3MOCC00034	ACTUATOR CENTRAL BRUSH	1		
SK1	3MECE00025	PCB	1		
SK2	3MECE00020	BOARD DISPLAY	1		
TR1	3MECE00408	TRANSFORMER FOR BATTERY CHARGER	1		

